

CLARKE®



OSCILLATING BELT/BOBBIN SANDER MODEL NO: COEBS1

PART NO: 6500460

OPERATION & MAINTENANCE INSTRUCTIONS



LS0416

INTRODUCTION

Thank you for purchasing this CLARKE product.

Before attempting to use this product, please read this manual thoroughly and follow the instructions carefully. In doing so you will ensure the safety of yourself and that of others around you, and you can look forward to your purchase giving you long and satisfactory service.

GUARANTEE

This product is guaranteed against faulty manufacture for a period of 12 months from the date of purchase. Please keep your receipt which will be required as proof of purchase.

This guarantee is invalid if the product is found to have been abused or tampered with in any way, or not used for the purpose for which it was intended.

Faulty goods should be returned to their place of purchase, no product can be returned to us without prior permission.

This guarantee does not effect your statutory rights.

ENVIRONMENTAL RECYCLING POLICY



Through purchase of this product, the customer is taking on the obligation to deal with the WEEE in accordance with the WEEE regulations in relation to the treatment, recycling & recovery and environmentally sound disposal of the WEEE.

In effect, this means that this product must not be disposed of with general household waste. It must be disposed of according to the laws governing Waste Electrical and Electronic Equipment (WEEE) at a recognised disposal facility.

GENERAL SAFETY RULES



WARNING: READ ALL INSTRUCTIONS. FAILURE TO FOLLOW ALL INSTRUCTIONS LISTED BELOW MAY RESULT IN ELECTRIC SHOCK, FIRE AND/OR SERIOUS INJURY.

1. Keep work area clear

- Cluttered areas and benches invite injuries.

2. Consider work area environment

- Do not expose tools to rain.
- Do not use tools in damp or wet locations.
- Keep work area well lit.
- Do not use tools in the presence of flammable liquids or gases.

3. Guard against electric shock

- Avoid body contact with earthed or grounded surfaces (e.g. pipes, radiators, ranges, refrigerators).

4. Keep other persons away

- Do not let persons, especially children, not involved in the work touch the tool or the extension cord and keep them away from the work area.

5. Store idle tools

- When not in use, tools should be stored in a dry locked-up place, out of reach of children.

6. Use protective equipment

- Use safety glasses.
- Use face or dust mask if working operations create dust.

7. Do not force the tool

- It will do the job better and safer at the rate for which it was intended.

8. Use the right tool

- Do not force small tools to do the job of a heavy duty tool.
- Do not use tools for purposes not intended; for example do not use circular saws to cut tree limbs or logs.

9. Dress properly

- Do not wear loose clothing or jewellery, they can be caught in moving parts.
- Non-skid footwear is recommended when working outdoors.
- Wear protective hair covering to contain long hair.

10. Dust extraction equipment

- Ensure dust extraction equipment is used.

11. Do not abuse the cord

- Never yank the cord to disconnect it from the socket. Keep the cord away from heat, oil and sharp edges.

12. Secure the work

- Where possible use clamps or a vice to hold the work. It is safer than using your hand.

13. Do not overreach

- Keep proper footing and balance at all times.

14. Maintain tools with care

- .
- Inspect tool cords periodically and if damaged have them repaired by an authorized service facility.
- Inspect extension cords periodically and replace if damaged.
- Keep handles dry, clean and free from oil and grease.

15. Disconnect tools

- When not in use, before servicing and when changing accessories such as blades, bits and cutters, disconnect tools from the power supply.

16. Remove adjusting keys and wrenches

- Form the habit of checking to see that keys and adjusting wrenches are removed from the tool before turning it on.

17. Avoid unintentional starting

- Ensure switch is in "off" position when plugging in.

18. Use outdoor extension leads

- When the tool is used outdoors, use only extension cords intended for outdoor use and so marked.

19. Stay alert

- Watch what you are doing, use common sense and do not operate the tool when you are tired.

20. Check damaged parts

- Before further use of tool, it should be carefully checked to determine that it will operate properly and perform its intended function.
- Check for alignment of moving parts, binding of moving parts, breakage of parts, mounting and any other conditions that may affect its operation.
- A guard or other part that is damaged should be properly repaired or replaced by an authorized service centre unless otherwise indicated in this instruction manual.
- Have defective switches replaced by an authorized service centre.
- Do not use the tool if the switch does not turn it on and off.

21. Warning

- The use of any accessory or attachment other than those recommended in this instruction manual may present a risk of personal injury.

22. Have your tool repaired by a qualified person

- This electric tool complies with the relevant safety rules. Repairs should only be carried out by qualified persons using original spare parts, otherwise this may result in considerable danger to the user.

SANDER SPECIFIC RULES

- **FIRMLY CLAMP OR BOLT** your sander to a workbench or table at approximately hip height.
- **NEVER** stand or have any part of your body in line with the path of the workpiece.
- **PLAN YOUR WORK TO REDUCE THE RISK OF THROWBACKS** (when the workpiece catches the sanding drum and is torn from your hands).
- **MAKE SURE THERE IS NO DEBRIS** between the workpiece and its supports.
- **WHEN SANDING IRREGULARLY SHAPED WORKPIECES**, plan your work support so it will not slip and be pulled from your hands.
- **USE EXTRA CAUTION WITH LARGE**, very small or awkward workpieces.
- **NEVER USE THIS SANDER** to finish pieces too small to hold by hand.
- **USE EXTRA SUPPORTS** (TABLES, SAW HORSES, BLOCKS, ETC.) for any workpieces large enough to tip when not secured to the work surface.
- **NEVER** sand more than one piece at a time. **DO NOT STACK** more than one workpiece on the sander table at a time.
- **ALWAYS FEED WORKPIECE FROM LEFT TO RIGHT** against the direction the drum sleeve is rotating.
- **DO NOT USE DRUMS**, sanding sleeves or belts which show visual signs of wear such as grooves, tears or rips.
- **ALWAYS STAY ALERT!** Do not allow familiarity (gained from frequent use of your sander) to cause a careless mistake. **ALWAYS REMEMBER** that a careless fraction of a second is sufficient to inflict severe injury.
- **MAKE SURE THE WORK AREA HAS AMPLE LIGHTING** to see the work and that no obstructions will interfere with safe operation **BEFORE** performing any work using your sander.
- **ALWAYS TURN OFF THE SANDER** before disconnecting it to avoid accidental starting when reconnecting to power supply.
- **NEVER** leave the sander unattended while connected to a power source.
- **SUPPORT WORKPIECE** with mitre gauge, work rest, or worktable.
- **SAVE THESE INSTRUCTIONS.** Refer to them frequently and use them to instruct others who may use this sander. If you loan someone this sander, loan them these instructions also.





SANDING DUST SAFETY WARNINGS

Some dust created by sanding, and other construction activities contains chemicals known to cause cancer, birth defects or other reproductive harm. Some examples of these chemicals are:

- lead from lead-based paints,
- crystalline silica from bricks and cement and other masonry products, and
- arsenic and chromium from chemically-treated lumber.

Your risk from these exposures varies, depending on how often you do this type of work. To reduce your exposure to these chemicals: work in a well ventilated area, and work with approved safety equipment, such as those dust masks that are specially designed to filter out microscopic particles.

SAFETY SYMBOLS

	Read this instruction booklet carefully.		Wear ear protection.
	Wear eye protection.		Wear a dust mask that is specially designed to filter microscopic particles.

ELECTRICAL CONNECTIONS



WARNING: READ THESE ELECTRICAL SAFETY INSTRUCTIONS THOROUGHLY BEFORE CONNECTING THE PRODUCT TO THE MAINS SUPPLY.

Connect the mains lead to a standard, 230 Volt (50Hz) electrical supply through an approved 13 amp BS 1363 plug, or a suitably fused isolator switch. If the plug has to be changed because it is not suitable for your socket, or because of damage, it must be removed and a replacement fitted, following the wiring instructions shown below. The old plug must be discarded safely, as insertion into a power socket could cause an electrical hazard.



**WARNING: THE WIRES IN THE POWER CABLE OF THIS PRODUCT ARE COLOURED IN ACCORDANCE WITH THE FOLLOWING CODE:
BLUE = NEUTRAL BROWN = LIVE**

If the colours of the wires in the power cable do not agree with the markings on the plug.

- The BLUE wire must be connected to the terminal which is marked N or coloured black.
- The BROWN wire must be connected to the terminal which is marked L or coloured red.

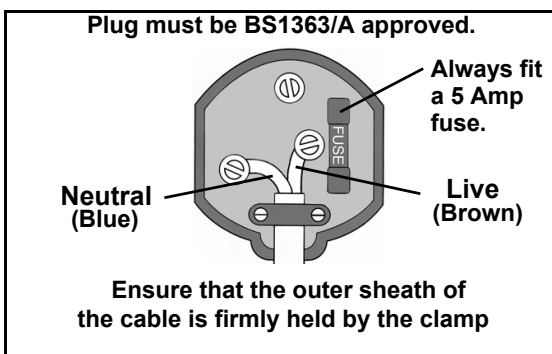

AN APPROVED RESIDUAL CURRENT DEVICE (RCD) WHICH HAS A TRIPPING CURRENT OF LESS THAN 30mA MUST BE USED.

If you are not sure, consult a qualified electrician. DO NOT try to do any repairs



This symbol indicates that this is a Class II product, and does not require an earth connection.

CONTENTS

The following items should be supplied in the carton. If any parts are missing, do not operate until the missing parts are replaced. Failure to follow this instruction could result in serious injury.



ASSEMBLY

SECURING THE SANDER TO A WORKBENCH

If sander is to be used in a permanent location, it should be fastened securely to a workbench via the four securing holes (one on each corner).

1. Mark out the position of the holes.
2. Secure using suitable bolts, washers, and nuts (not supplied).

An alternative method is to fasten the sander to a mounting board.

The board should be sufficient size to avoid tipping while in use. Any good grade of 3/4" plywood or chipboard will be sufficient.

The mounting board can then be clamped to a workbench when required.

DUST EXTRACTION



WARNING: CONTACT WITH, OR INHALATION OF DUST FROM LEAD BASED PAINTS CAN ENDANGER THE HEALTH OF THE OPERATOR AND BYSTANDERS. ALWAYS WEAR A SUITABLE DUST MASK WHEN USING THE SANDER.

1. Connect a suitable dust collector to the dust extraction port.
 - The dust exhaust port has an internal diameter of 36 mm and an outside diameter of 39 mm.

NOTE: Even with a dust collection system, it is necessary to periodically clean sanding dust from the recess in the table. A build up of dust in the table recess may prevent the belt or spindle from making a complete oscillation.

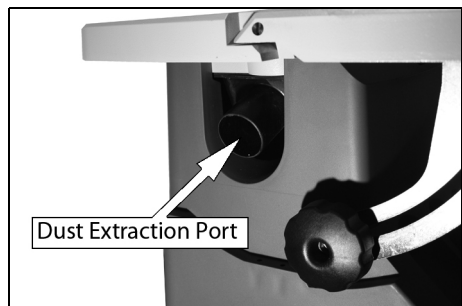

EDGE SANDING SETUP

INSTALL THE SANDING BELT ASSEMBLY

1. If fitted, remove the fan and table insert from the sander.
 - Clear the recess of any debris.
2. Slide the fan onto the motor shaft (vanes face down).
 - You may need to rotate the fan to get it to locate properly, (when correctly fitted the fan rotates with the spindle).
 - The fan must be used at all times.
3. Slide sanding belt assembly over the spindle as shown.

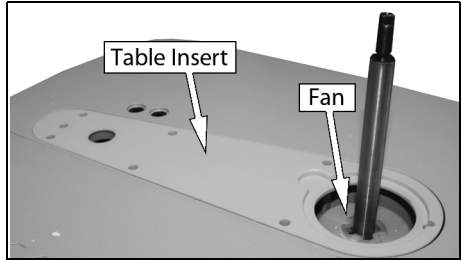

4. Fit the washer and hand nut.
 - Do not overtighten the hand nut.
5. Install the sanding belt (See "Removing/installing the Sanding Belt" on page 11).
6. Place the backstop into position and secure in place with the backstop securing bolt.

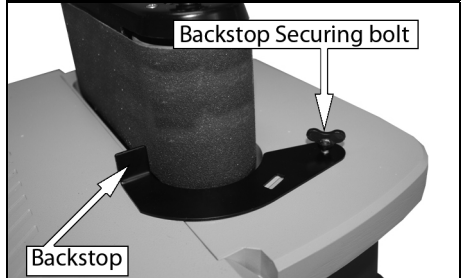
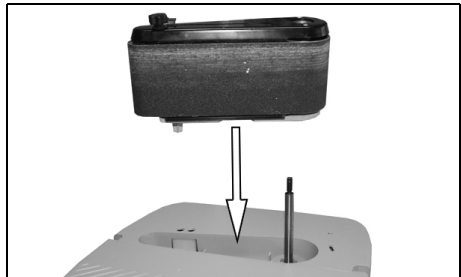

REMOVING/INSTALLING THE SANDING BELT

WARNING: MAKE SURE THAT THE TOOL IS UNPLUGGED BEFORE INSTALLING/REMOVING THE SANDING BELT.



1. Move the belt tension lever fully to the right as shown.

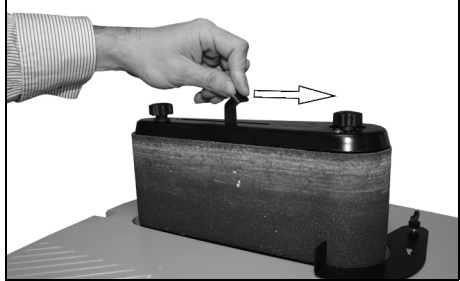

2. Slide the belt over the rollers and centralise the belt.

- The arrows on the sanding belt and machine should be pointing in the same direction.

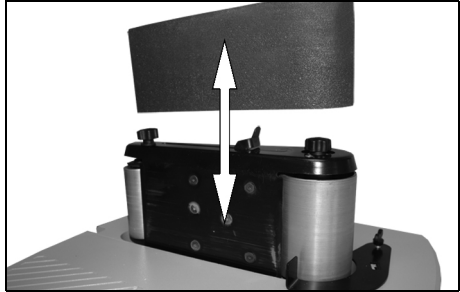

3. Move the belt tensioning lever to the left.

- Keep the belt tensioning lever under control at all times, do not allow it to spring back.
- Make sure the belt tracks correctly before use. See "Sanding Belt Tracking" on page 12.



SANDING BELT TRACKING

- Plug in the power cable. Turn the switch ON and immediately turn the switch OFF again. Note if the belt tends to slide off the drums.
 - If it did not tend to slide off, it is tracking properly.
 - If the sanding belt runs down (towards the table), turn the tracking knob clockwise 1/4 turn.
 - If the sanding belt runs up (away from the table), turn the tracking knob counterclockwise 1/4 turn.
- Turn the switch ON and immediately OFF again, noting belt movement. Readjust the tracking knob if necessary.

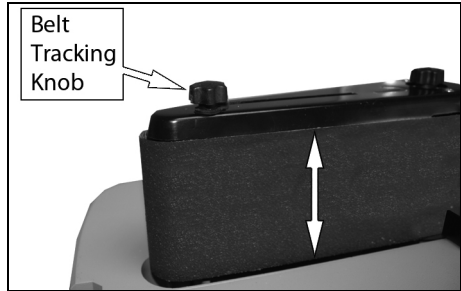

BOBBIN SANDING SETUP

SELECTION OF SPACER RING INSERTS AND SPINDLE WASHERS

You must use the correct spacer ring and washers when fitting the bobbins

Bobbin Size	What Sanding Sleeve should you use	What drum should you use	What spacer ring should you use (inside diameter)	What washer should you use
1/2"	1/2"	None	1/2"	Small
3/4"	3/4"	3/4"	3/4"	Small
1"	1"	1"	1"	Medium
1 1/2"	1 1/2"	1 1/2"	1 1/2"	Medium
2"	2"	2"	2"	Large

ASSEMBLING THE BOBBIN

Slide the sanding sleeve over the drum as shown.

- If the sanding sleeve is difficult to slide over the drum, apply talcum powder to the outside surface of the drum.
- The smallest sanding sleeve slides directly onto the spindle shaft and does not require a drum.

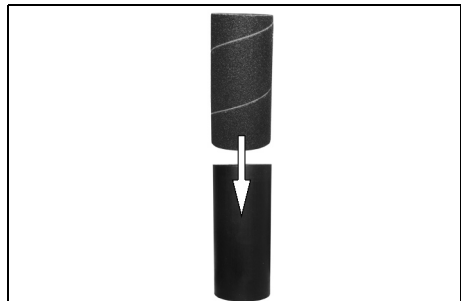

FITTING THE BOBBIN TO THE SANDER



WARNING: TO REDUCE THE RISK OF INJURY FROM ACCIDENTAL STARTING, MAKE SURE THE SANDER IS UNPLUGGED BEFORE REMOVING OR REPLACING THE SPACER RING INSERTS, SLEEVES AND DRUMS.

1. If fitted, remove the fan and table insert from the sander.
2. Clear the recess of any debris.
3. Slide the fan back on to the spindle (vanes face down) and engaged fully.
 - The fan must be used at all times.
4. Replace the table insert.
5. Slide the bobbin onto the spindle.

NOTE: The smallest sanding sleeve slides directly onto the spindle shaft and not onto a drum.

6. Position the spacer ring in the recess on the table insert.
 - Use the smallest spacer ring insert that will fit over the drum.
7. Install the correct washer.
 - Use the largest washer that does not overhang the sanding sleeve.
8. Secure everything in place with the spindle nut.
 - A spindle nut wrench is supplied.

NOTE: As you tighten the spindle nut, the drum expands outwards slightly to hold the sanding sleeve secure.

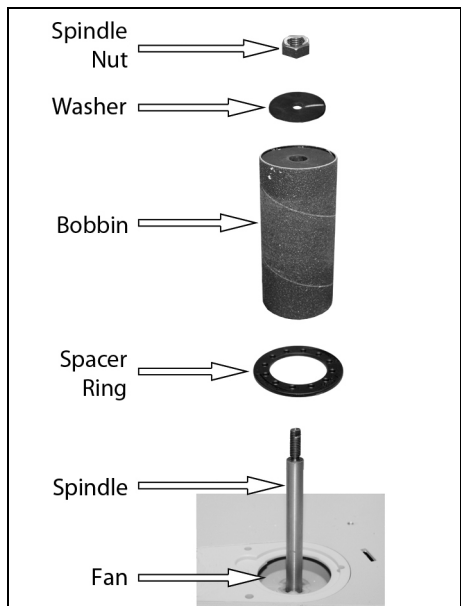
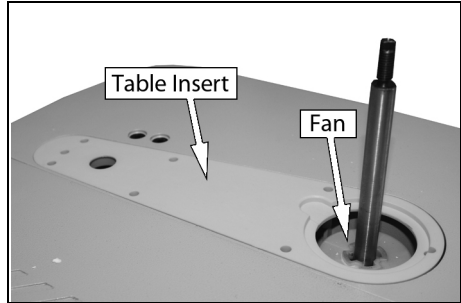

USING THE SANDER



CAUTION: BEFORE TURNING THE SWITCH ON, MAKE SURE THE BELT OR DRUM AND SLEEVE ARE PROPERLY INSTALLED.



WARNING: ALWAYS WEAR SAFETY GOGGLES OR SAFETY GLASSES WITH SIDE SHIELDS WHEN OPERATING POWER TOOLS. FAILURE TO DO SO COULD RESULT IN OBJECTS BEING THROWN INTO YOUR EYES, RESULTING IN POSSIBLE SERIOUS INJURY.

ON-OFF SWITCH

Press green button " - " to turn switch ON

Press red button " O " to turn switch OFF.

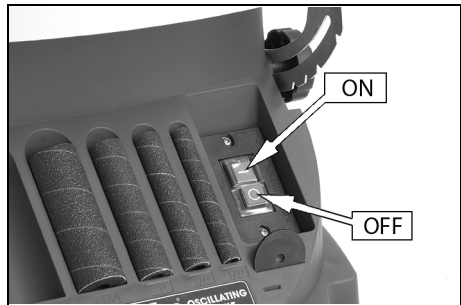

WHEN THE SANDER IS RUNNING

Before starting your work, watch the sander while it runs.

If it makes an unfamiliar noise or vibrates excessively, stop immediately. Switch off and unplug the sander. Do not restart until identifying and correcting the problem.

Don't force the sander. It will perform better and safer at its designed rate. Press workpiece against the sanding sleeve or belt hard enough to begin sanding without binding.

BEFORE FREEING ANY JAMMED MATERIAL

- Switch OFF (O).
- Unplug the sander.
- Wait for all moving parts to stop.

BEFORE LEAVING THE SANDER

- Switch off. Do not leave the sander until the unit comes to a complete stop.

ADJUSTING THE TABLE ANGLE



WARNING: BEFORE PERFORMING ANY ADJUSTMENT, MAKE SURE THE SANDER IS SWITCHED OFF AND UNPLUGGED FROM THE POWER SUPPLY. FAILURE TO HEED THIS WARNING COULD RESULT IN SERIOUS PERSONAL INJURY.

1. Loosen the table adjustment knobs (one each side) and move the table to the required angle.
 - There are stops on the right hand bracket at the following angles 0, 15, 22.5, 30, and 45 degrees.
 - Use a protractor or set square to confirm the angle.
2. Retighten both table adjustment knobs.

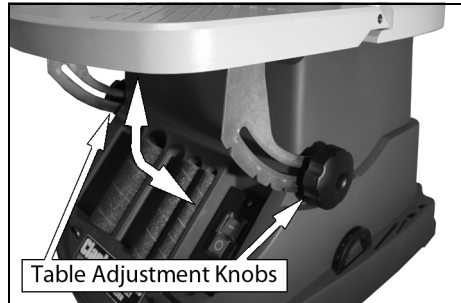

PARTS STORAGE

1. The storage slots on the front are used to store bobbins/sanding sleeves and washers.
2. Spindle nut wrench and spacer rings are stored on the sides.
3. The edge sander is stored at the rear.

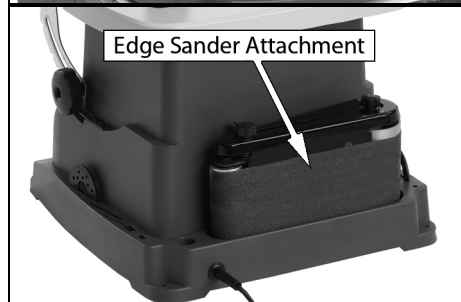
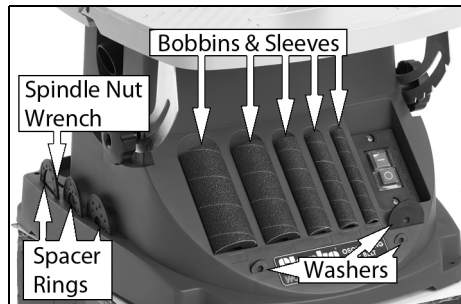

TROUBLESHOOTING

Trouble	Possible Cause	Solution
Sander will not start	Sander unplugged from wall Fuse blown or circuit breaker tripped Cable damaged	Check all plug connections Replace fuse or reset circuit breaker Replace the cable
Sanding belt does not come up to speed	Extension cable too light or too long Low current	Replace with adequate size and length cable Contact a qualified electrician
Abrasive belt keeps tearing	Belt is running in the wrong direction	Arrow on the sanding belt and machine should be pointing in the same direction
Sanded edge not square	Table not square to sanding platen	Use a square to adjust table to sanding platen
Sanding marks on wood	Wrong grit sanding belt Feed pressure too great Sanding against the grain	Use coarser grit for stock removal and fine grit for finish sanding. Never force work into sanding platen Sand with the grain

MAINTENANCE



WARNING: REMOVE THE PLUG FROM THE MAINS POWER SUPPLY BEFORE CARRYING OUT ANY ADJUSTMENT, SERVICING OR MAINTENANCE

PERIODICALLY

- Keep the ventilation holes clear and free from blockages.
- Wipe the unit with a damp cloth, do not use abrasive chemicals to clean the sander.

LUBRICATION

- All of the bearings in this sander are lubricated with a sufficient amount of high grade lubricant for the life of the unit under normal operating conditions. Therefore, no further lubrication is required.

REPLACEMENT SANDING SLEEVES

	Part Number
Sanding Belt	6500462
Sanding Drums (x 4)	6500464
Sanding Sleeve 80 Grit (x5)	6500466
Sanding Sleeve 150 Grit (x5)	6500468
Sanding Sleeve 240 Grit (x5)	6500470

SPECIFICATIONS

Model Number	COEBS1
No load speed - Spindle	2000 RPM
No load speed - Belt	1750 RPM
Sanding Table Dimensions: (Depth x Width)	418 x 401 mm
Table Height	334 mm
Bobbin Length	116 mm
Dust Extraction	I.D : 36 mm, O.D : 39 mm
Operating Voltage and Frequency	230V @ 50Hz
Input Power @ Rated Load	450W
Sanding Sleeve Diameters	½", ¾", 1", 1½", 2"
Grit grades	80 grit
Sound Pressure level : LpA	76 dB
Sound Power level: LWA	89 dB
Uncertainty Factor K	3 dB
Dimensions (L x W x H)	456 x 417 x 455 mm
Weight	12.4 kg

The details and specifications contained herein, are correct at the time of going to print. We reserve the right to change specifications without prior notice

EXPLODED DIAGRAM AND PARTS LIST

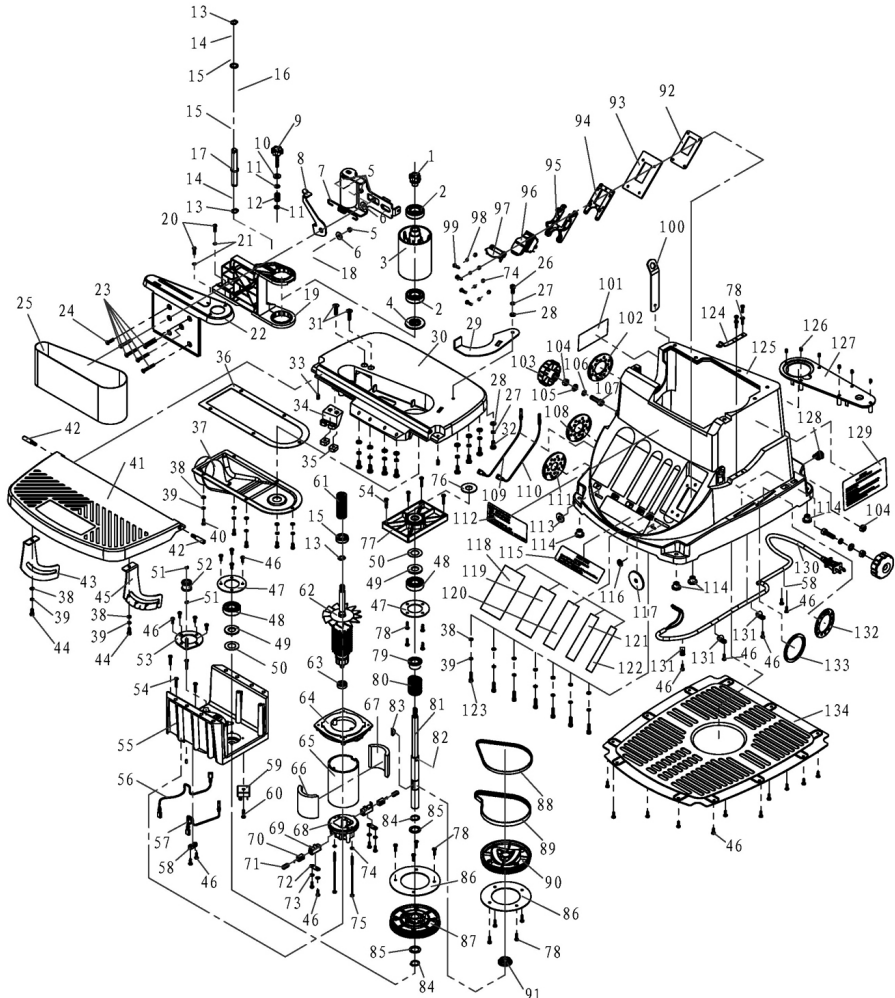

1	Knob	KTCOEB1001
2	Bearing 604	KTCOEB1002
3	Sanding Drum	KTCOEB1003
4	Fan	KTCOEB1004
5	Hexagon Nuts M5	KTCOEB1005
6	Tension Plate Gasket	KTCOEB1006
7	Tension Spring	KTCOEB1007
8	Belt Tension Lever	KTCOEB1008
9	Tracking Knob	KTCOEB1009
10	Rubber Gaskets B	KTCOEB1010
11	Gasket	KTCOEB1011
12	Spring	KTCOEB1012
13	Shaft Circlip 12	KTCOEB1013
14	Drum Axle Shim	KTCOEB1014
15	Bearing 601	KTCOEB1015
16	Small Wheel	KTCOEB1016
17	Small Drum Axle	KTCOEB1017
18	Small Drum Bracket	KTCOEB1018
19	Drum Stand	KTCOEB1019
20	Cross Recessed Pan Head Screws	KTCOEB1020
21	External Tooth Lock Washer	KTCOEB1021
22	Sanding Belt Assembly Cover	KTCOEB1022
23	Hexagon Socket Countersunk Head Screws	KTCOEB1023
24	Hexagon Socket Countersunk Head Screws	KTCOEB1024
25	4"X23" Sanding Belt	KTCOEB1025
26	Socket Head Cap Screws	KTCOEB1026
27	Spring Gasket 6mm	KTCOEB1027
28	Flat Washer 6mm	KTCOEB1028
29	Backstop	KTCOEB1029
30	Main Work Bench	KTCOEB1030
31	Hexagon Socket Countersunk Head Screws	KTCOEB1031
32	Cross Recessed Pan Head Screws	KTCOEB1032
33	Hexagon Set Screws	KTCOEB1033

34	Flexible Slider	KTCOEB1034
35	Square Nuts M6	KTCOEB1035
36	Rubber Gasket	KTCOEB1036
37	Dust Guide B	KTCOEB1037
38	Flat Washer	KTCOEB1038
39	Spring Gasket	KTCOEB1039
40	Cross Recessed Pan Head Screws	KTCOEB1040
41	Flexible Work Bench	KTCOEB1041
42	Rotary Screw	KTCOEB1042
43	Right Angle Board	KTCOEB1043
44	Socket Head Cap Screws	KTCOEB1044
45	Left Angle Board	KTCOEB1045
46	Self-tapping Screws	KTCOEB1046
47	Bearing Retainer	KTCOEB1047
48	Bearing 6203	KTCOEB1048
49	Wool Felt	KTCOEB1049
50	Rubber Gasket B	KTCOEB1050
51	Shaft Circlip	KTCOEB1051
52	Tensioner Assembly	KTCOEB1052
53	Positioning Plate Assembly	KTCOEB1053
54	Self-tapping Screws	KTCOEB1054
55	Pulley Bracket	KTCOEB1055
56	Cable Assembly (1)	KTCOEB1056
57	Cable Assembly (2)	KTCOEB1057
58	Wire Crimping Board	KTCOEB1058
59	Bridge Reactor	KTCOEB1059
60	Self-tapping Screws	KTCOEB1060
61	Long Pulley	KTCOEB1061
62	Rotor Assembly	KTCOEB1062
63	Bearing 608	KTCOEB1063
64	Connecting Plate	KTCOEB1064
65	Cylinder	KTCOEB1065
66	Magnetic Tile	KTCOEB1066
67	Magnetic Tile	KTCOEB1067
68	Rear End	KTCOEB1068
69	Brush Holder	KTCOEB1069
70	Carbon Brush	KTCOEB1070

71	Carbon Brush Spring	KTCOEB1071
72	Crimping Board	KTCOEB1072
73	Internal Tooth Lock Washers 4	KTCOEB1073
74	Flat Washer 4	KTCOEB1074
75	Self-tapping Screw	KTCOEB1075
76	Rubber Dust Washer	KTCOEB1076
77	Bearing Cover	KTCOEB1077
78	Self-tapping Screws	KTCOEB1078
79	Large Bearing Sleeve	KTCOEB1079
80	Compression Spring	KTCOEB1080
81	Spindle	KTCOEB1081
82	Roll Pin	KTCOEB1082
83	Woodruff Key	KTCOEB1083
84	Circlip 17	KTCOEB1084
85	Output Shaft Washer	KTCOEB1085
86	Pulley Damper	KTCOEB1086
87	Drive Pulley	KTCOEB1087
88	Synchronous Belt	KTCOEB1088
89	Synchronous Belt (2)	KTCOEB1089
90	Driven Pulley	KTCOEB1090
91	Small Bearing Sleeve	KTCOEB1091
92	Switch Positioning Plate	KTCOEB1092
93	Switch Plate	KTCOEB1093
94	Switch Locating Ring (Down)	KTCOEB1094
95	Switch Locating Ring (Up)	KTCOEB1095
96	Switch Assembly	KTCOEB1096
97	Switch-assisted Positioning Ring	KTCOEB1097
98	Spring Washers 4	KTCOEB1098
99	Phillips Flat-head Screws	KTCOEB1099
100	Wrench	KTCOEB1100
101	Warning Label	KTCOEB1101
102	Plastic Washers (3)	KTCOEB1102
103	Knob	KTCOEB1103
104	Hex Nuts M8	KTCOEB1104
105	Flat Washer 8	KTCOEB1105
106	Spring Washer 8	KTCOEB1106

107	Socket Head Cap Screws	KTCOEB1107
108	Plastic Washer(4)	KTCOEB1108
109	Motor Cable Assembly(1)	KTCOEB1109
110	Motor Cable Assembly(2)	KTCOEB1110
111	Plastic Washer(5)	KTCOEB1111
112	Name Plate	KTCOEB1112
113	Gasket(2)	KTCOEB1113
114	Rubber Foot	KTCOEB1114
115	Trademark	KTCOEB1115
116	Gasket(3)	KTCOEB1116
117	Gasket(1)	KTCOEB1117
118	Sanding Sleeve 1	KTCOEB1118
119	Sanding Sleeve 2	KTCOEB1119
120	Sanding Sleeve 3	KTCOEB1120
121	Sanding Sleeve 4	KTCOEB1121
122	Sanding Sleeve 5	KTCOEB1122
123	Allen Screws	KTCOEB1123
124	Indexing Plate	KTCOEB1124
125	Plastic Base	KTCOEB1125
126	Hexagon Set Screws	KTCOEB1126
127	Plastic Panel	KTCOEB1127
128	Line Card	KTCOEB1128
129	Warning Signs (2)	KTCOEB1129
130	Power Cable	KTCOEB1130
131	Xlsr Type Fixing Clip	KTCOEB1131
132	Plastic Washers(2)	KTCOEB1132
133	Plastic Washers	KTCOEB1133
134	Plastic Bottom Plate	KTCOEB1134

0

DECLARATION OF CONFORMITY



Clarke[®]
INTERNATIONAL

Hemnall Street, Epping, Essex CM16 4LG

DECLARATION OF CONFORMITY

This is an important document and should be retained.

We hereby declare that this product(s) complies with the following directive(s):

2014/30/EU *Electromagnetic Compatibility Directive.*
2006/42/EC *Machinery Directive.*
2011/65/EU *Restriction of Hazardous substances.*

The following standards have been applied to the product(s):

*EN 61029-1:2009+A11:2010, EN ISO 12100:2010, EN 55014-1:2006 +A2:2011,
EN 55014-2:1997+A2:2008, EN 61000-3-2:2014, EN 61000-3-3:2013.*

The technical documentation required to demonstrate that the product(s) meet(s) the requirement(s) of the aforementioned directive(s) has been compiled and is available for inspection by the relevant enforcement authorities.

The CE mark was first applied in: 2015

Product Description: Oscillating Edge Belt Sander
Model number(s): COEBS1
Serial / batch Number: N/A
Date of Issue: 12/02/2016

Signed:

J.A. Clarke
Director

A SELECTION FROM THE VAST RANGE OF

Clarke®

QUALITY PRODUCTS

AIR COMPRESSORS

From DIY to industrial, Plus air tools, spray guns and accessories.

GENERATORS

Prime duty or emergency standby for business, home and leisure.

POWER WASHERS

Hot and cold, electric and engine driven - we have what you need

WELDERS

Mig, Arc, Tig and Spot. From DIY to auto/industrial.

METALWORKING

Drills, grinders and saws for DIY and professional use.

WOODWORKING

Saws, sanders, lathes, mortisers and dust extraction.

HYDRAULICS

Cranes, body repair kits, transmission jacks for all types of workshop use.

WATER PUMPS

Submersible, electric and engine driven for DIY, agriculture and industry.

POWERTOOLS

Angle grinders, cordless drill sets, saws and sanders.

STARTERS/CHARGERS

All sizes for car and commercial use.



PARTS & SERVICE: 0208 988 7400

E-mail: Parts@clarkeinternational.com or Service@clarkeinternational.com

SALES: UK 01992 565333 or Export 00 44 (0)1992 565335

Clarke® INTERNATIONAL Hemnall Street, Epping, Essex CM16 4LG
www.clarkeinternational.com